



GALAXY MOTORS



PRODUCT RANGE



GALAXY 26E DUAL ACTUATOR
PAGE. 04



GALAXY 26W WIRELESS
DUAL ACTUATOR
PAGE. 05



GALAXY 26WL WIRELESS &
LED DUAL ACTUATOR
PAGE. 06



GALAXY 26EHL DUAL ACTUATOR
PAGE. 07



GALAXY 16E DUAL MOTOR
PAGE. 08



GALAXY 26W WIRELESS
DUAL ACTUATOR
PAGE. 09



GALAXY 26WL WIRELESS &
LED DUAL ACTUATOR
PAGE. 10



GALAXY 26EHL DUAL
ACTUATOR
PAGE. 11



GALAXY 16E DUAL MOTOR
PAGE. 12



GALAXY 26W WIRELESS
DUAL ACTUATOR
PAGE. 13



GALAXY 26WL WIRELESS &
LED DUAL ACTUATOR
PAGE. 14



HANDSETS
PAGE. 15-16-17

GALAXY 26E DUAL ACTUATOR



SPECIFICATIONS

Max. push force: 2 x 6500N
No-load speed: 4.3 mm/s
Installation dimension: 581 mm ± 2 mm
Appearance dimension: 775 x 170 x 120 mm



GALAXY 26W WIRELESS DUAL ACTUATOR



SPECIFICATIONS

Max. push force: 2 x 6500N
No-load speed: 4.3 mm/s
Installation dimension: 581 mm ± 2 mm
Appearance dimension: 775 x 170 x 120 mm



GALAXY 26WL WIRELESS & LED DUAL ACTUATOR



SPECIFICATIONS

Max. push force: 2 x 6500N
No-load speed: 4.3 mm/s
Installation dimension: 581 mm ± 2 mm
Appearance dimension: 775 x 170 x 120 mm
Option: under-bed light



GALAXY 26EHL DUAL ACTUATOR



GALAXY 16E DUAL MOTOR



SPECIFICATIONS

Max. push force: 2 x 6500N
 No-load speed: 5.6 mm/s
 Installation dimension: 581 mm +/- 1mm
 Appearance dimension: 767 x 121 x 169 mm



GALAXY 15 SINGLE MOTOR



Description

Specification

Max. load	Push force 6000N, Pull force 4000N
No-load speed	4 - 46 mm/s
Installation dimension	= stroke + 146 mm
Other options	Mechanical hand-protection function (push only) Hall sensor

Drawings (mm)

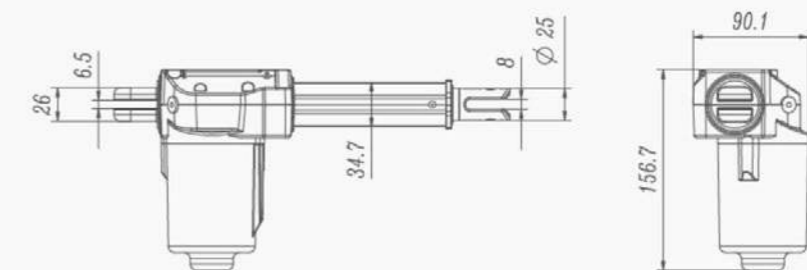

GALAXY 76 SINGLE MOTOR



GALAXY 77 SINGLE MOTOR



Specification

Max. load	Push force 6000N, Pull force 4000N
No-load speed	4 - 46 mm/s
Installation dimension	= stroke + 148 mm
Other options	Mechanical hand-protection function (push only) Hall sensor

Drawings (mm)

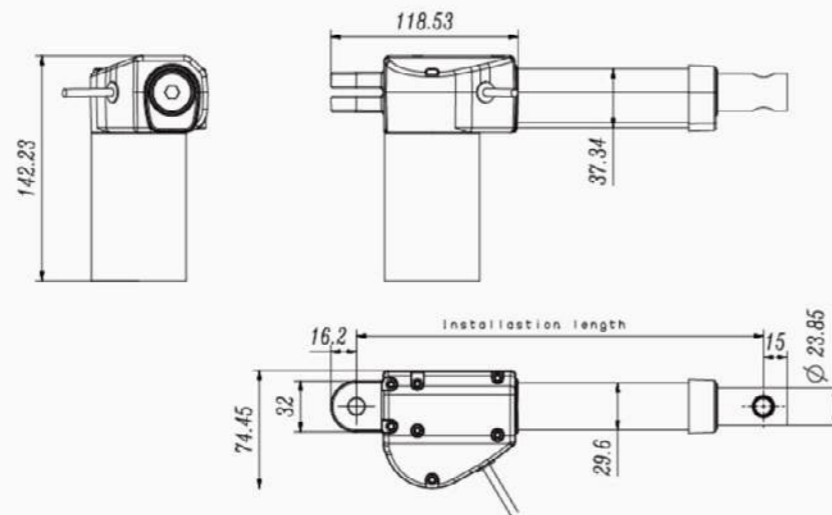

Description

Specification

Max. load	Push force 6000N, Pull force 4000N
No-load speed	4 - 46 mm/s
Installation dimension	= stroke + 175 mm
Other options	Mechanical hand-protection function (push only)

Drawings (mm)

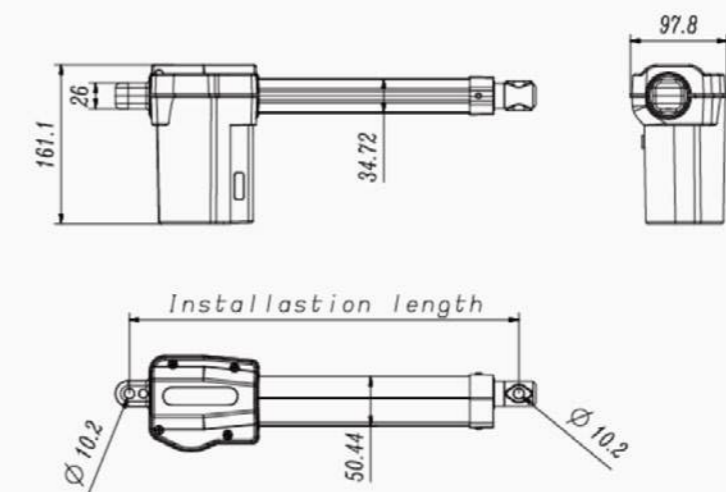

GALAXY 7 SINGLE MOTOR



Description

Specification

Max. load	Push force 6000N, Pull force 3000N
No-load speed	4 - 46 mm/s
Installation dimension	= stroke + 145 mm
Other options	Mechanical hand-protection function (push only) Hall sensor

Drawings (mm)

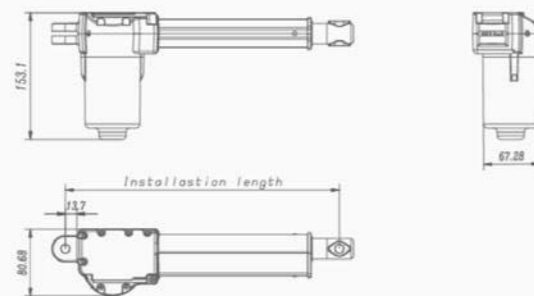

GALAXY 5 SINGLE MOTOR



Description

Specification

Protection type	IP20
Max. load	push force 6000N, pull force 4000N
No-load speed	4-46mm/s

Drawings (mm)

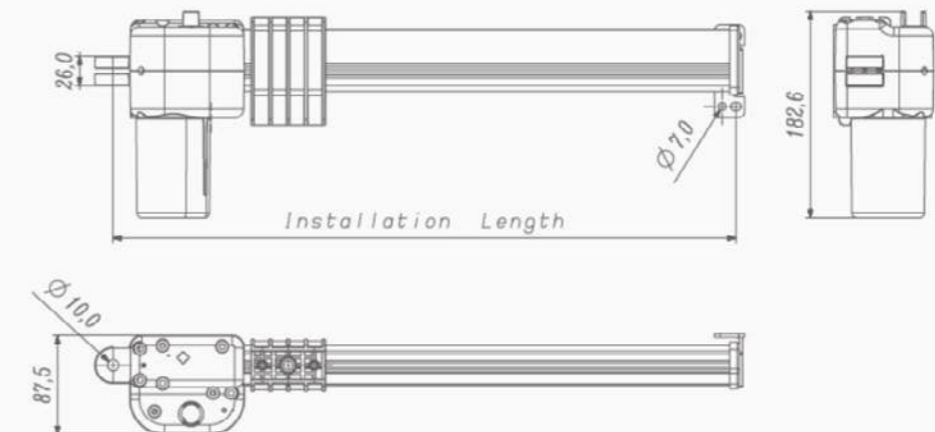

GALAXY 58 SINGLE MOTOR SMALL



Description

Specification

Max. load	push force 3000N, pull force 2000N
No-load speed	4-18mm/s
Installation dimension	= stroke + 165mm

Drawings (mm)

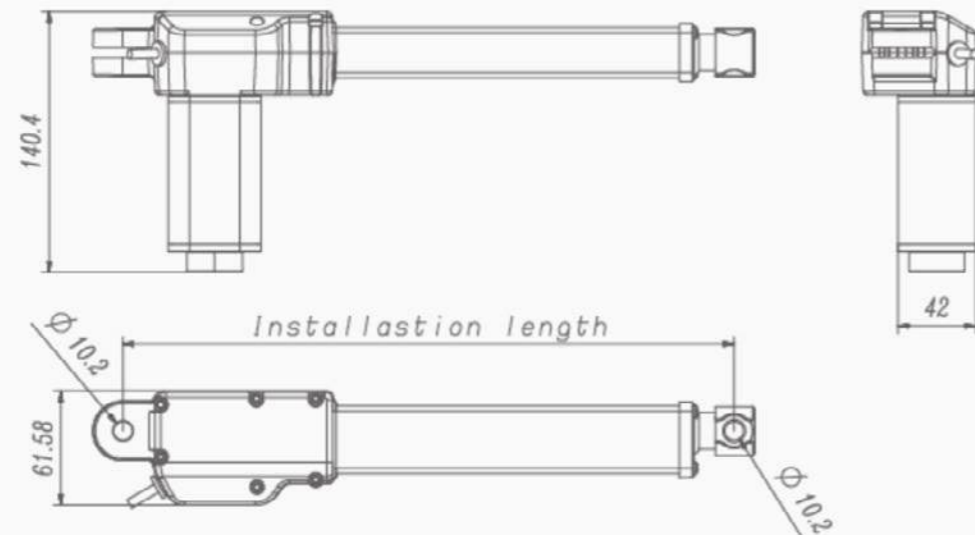

HANDSET



HS-16



HS-17



HS-18



HS-06



HS-07



HS-08



HS-09



HS-03



HS-04



HS-14

HANDSETS



HS-19



HS-20



HS-21



HS-22



HS-23



HS-01



HS-02



HS-05



HANDSETS



HS-10



HS-11



HS-12



HS-13



HS-15



GALAXY TECHNOLOGY



DOWNLOAD THE APPLICATION TO ENJOY THE COMFORT

There is no doubt that the time of sleeping and resting is the most important factor of healthy life. During that time when all physical functions are being regulated, the effect of bed is also as much important as the sleep itself. Smartrest mechanism, which has proven itself in the field of customized beds, offers you the freedom of controlling your bed as you like with the smart resting technology manufactured.

Designed for different needs at different times to make your life easier, Smartrest mechanisms can be set to the position you like at certain angles and the ideal sleeping position can be saved thanks to the application you will download to your mobile phone- and without troubling yourself!



YOU NOW HOLD THE COMFORT IN YOUR HANDS
WITH THE SMARTREST TECHNOLOGY



OPTIONAL FUNCTIONS



Smartrest mechanisms, which are easily adjustable with a single touch on a button, offer you countless relaxation positions to support your head, neck, shoulders, back, lower back, hip, legs and feet.



Adjust the position of your bed to your liking using the remote control technology! What is more, you can customize the double beds however you like. You can use one side of the bed flat while experiencing the freedom and convenience of shaping the other side the way you want!



Designed for different needs at different times to make your life easier, Smartrest mechanisms can be set to the position you like at certain angles and the ideal sleeping position can be saved thanks to the application you will download to your mobile phone- and without troubling yourself!



Smartrest technology offers you not only the significantly necessary musculoskeletal support and comfort but also relief of pain, regulated blood circulation and muscular and nervous system functions with its massage support technology.

OPTIONAL FUNCTIONS



The comfort of a fresh and healthy sleep is waiting for you with the Air Pass technology, which offers air permeability ensured by the metal mesh design and healthy and comfortable sleep for all.



With the silent motor technology of Smartrest, your sleeping and resting hours will now turn into fun...



Smartrest, the revolutionary mechanism of customized beds, has another innovation for those who are fond of their comfort. Do not miss on the freedom and convenience of setting the position of your bed to your liking, customizing it however you want and saving the setting.



The USB technology is undoubtedly one of the most important advancements of the recent technology world. The USB port in Smartrest mechanisms give you the freedom to charge any electronic device you have.

ST - 74-75 TV LIFT



ST - 73 TV LIFT



- TV Lift System
- A system that makes design easier in architectural applications
 - Protects TVs from external factors
 - Eliminates the problem of TV viewing angle
 - When preferred, the device cannot be handled by anyone except for the user
 - No additional space is required for the TV
 - Easy assembly since it is demountable





PRODUCT RANGE
ADJUSTABLE BED MECHANISM

STF-10-4K GOLD WAVE
Page. 28-33



PERFECT MOTION
Page. 34-41



STF-90-5K DOUBLE REST
Page. 42-47



FLEXMOTION
Page. 48-53



STF-15-4k RELAXMOTION
Page. 56



STF-88 CREATION
Page. 58



STF-67-4K
S-LINE METAL FRAME
Page. 59



STF-70 HIGH-LOW
PERFECT MOTION
Page. 60



STF-28-4K METAL FRAME
Page. 61



STF-25-4K METAL FRAME
Page. 62



STF-25-5K METAL FRAME
Page. 63



STF-27-4K
PULLBACK FRAME
Page. 64



PRODUCT RANGE

STF-27-5K
PULLBACK FRAME
Page. 65



STF-24-4K METAL FRAME
Page. 66



STF- 21 METAL FRAME
Page. 67



STF-23-5K METAL FRAME
Page. 68



STF-23-4K METAL FRAME
Page. 68



STF-22-4K METAL FRAME
Page. 69



STF-17-4K
Page. 70



STF-130-4K
MANUAL ADJUSTABLE BED
Page. 71



STF-119-4K
FOLDABLE SLETTED BED
Page. 71



STF-42-5K AIRBOXX FRAME
Page. 72



STF-37-4K
AIRBOXX FRAME
Page. 72



STF-45 AIRBOXX INSIDE
FIX FRAME MESH
Page. 73



PRODUCT RANGE

STF-141 SLETTED BED
Page. 73



STF-199 FOLDABLE
WOODEN BED
Page. 74



STF-195 FOLDABLE
AIRBOXX MESH BED
Page. 74



STF-110 FOLDABLE
SPRING BED
Page. 75



STF-140 FOLDABLE
METAL BED
Page. 75



STF-144 FOLDABLE
HOTEL BED
Page. 76



STF-190 TWIN BED
Page. 77



STF-69 BUNK BED MESH
Page. 78



STF-191 BUNK BED
Page. 79



STF-18-4K CARE BED
Page. 80-83



SYSTEM COMPONENTS
& ACCESSORIES
Page. 84-97





Revolutionized the customizable bed sector, Ersan has another innovation for those who are fond of their comfort. With Smartrest that can be set to the position you like using the remote control system, your sleeping and resting hours will now turn into fun...

Thanks to the mechanism system that consists of sections that are capable of moving independently from each other, you can set your bed to the sleeping position any time you want using the remote control technology.

Smartrest that has countless skills is operated with a single remote control to set the position desired to read a book, watch the TV or relax following a busy work schedule.

Thanks to the independently moving systems in double bed models that allow couples to set two sides of the bed however they like, the moving position changes of this special system also regulates your blood flow. Offering a relaxing massage effect against your neck, back and feet pain, the neck, lower back, back, hip and leg sections are tailor-made to your body to ensure a perfect fit.



PERFECT FIT TO SPINE STRUCTURE

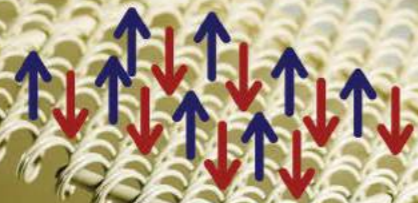

 **Air Pass**

The comfort of a fresh and healthy sleep is waiting for you with the Air Pass technology, which offers air permeability ensured by the metal mesh design and healthy and comfortable sleep for all.

PERFECT FIT TO SPINE STRUCTURE

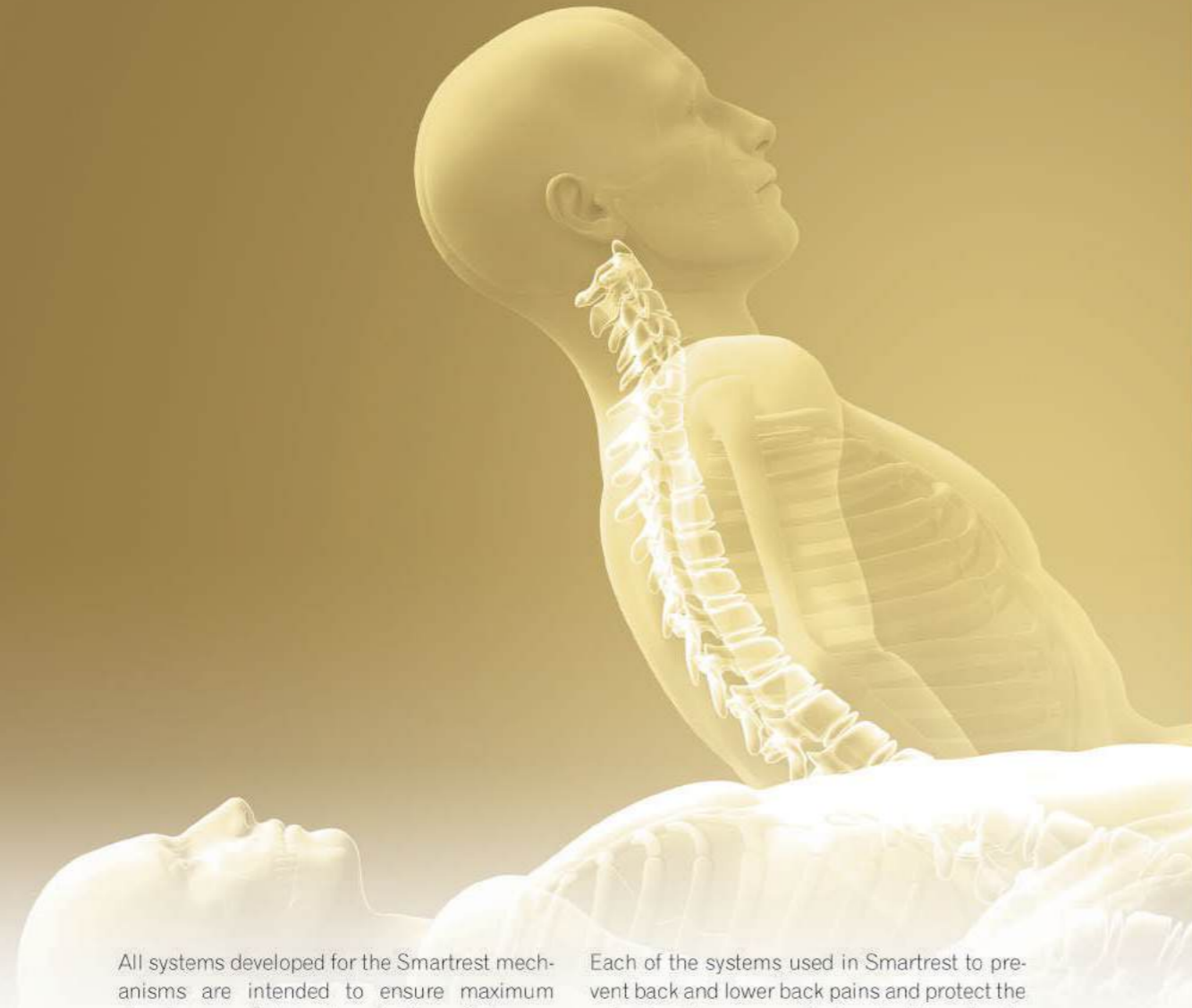

All systems developed for the Smartrest mechanisms are intended to ensure maximum sleeping comfort and protection of human health.

Therefore, the mechanism designs prepared with the helix metal systems we use in the mechanisms and have developed using advanced technologies have an ergonomic structure for the human body.

Each of the systems used in Smartrest to prevent back and lower back pains and protect the spine health are manufactured with a view to healthy life.

Moreover, the mechanisms featuring spring systems developed for maximum sleep comfort prevent the turning movements in bed at night from disturbing you and interrupting your sleep. This way, you will feel more energetic when you wake up in the morning.

STF-10-4K GOLD WAVE



AN ENGINEERING MARVEL WITH ITS DYNAMICS FIT
FOR THE JOINT STRUCTURE

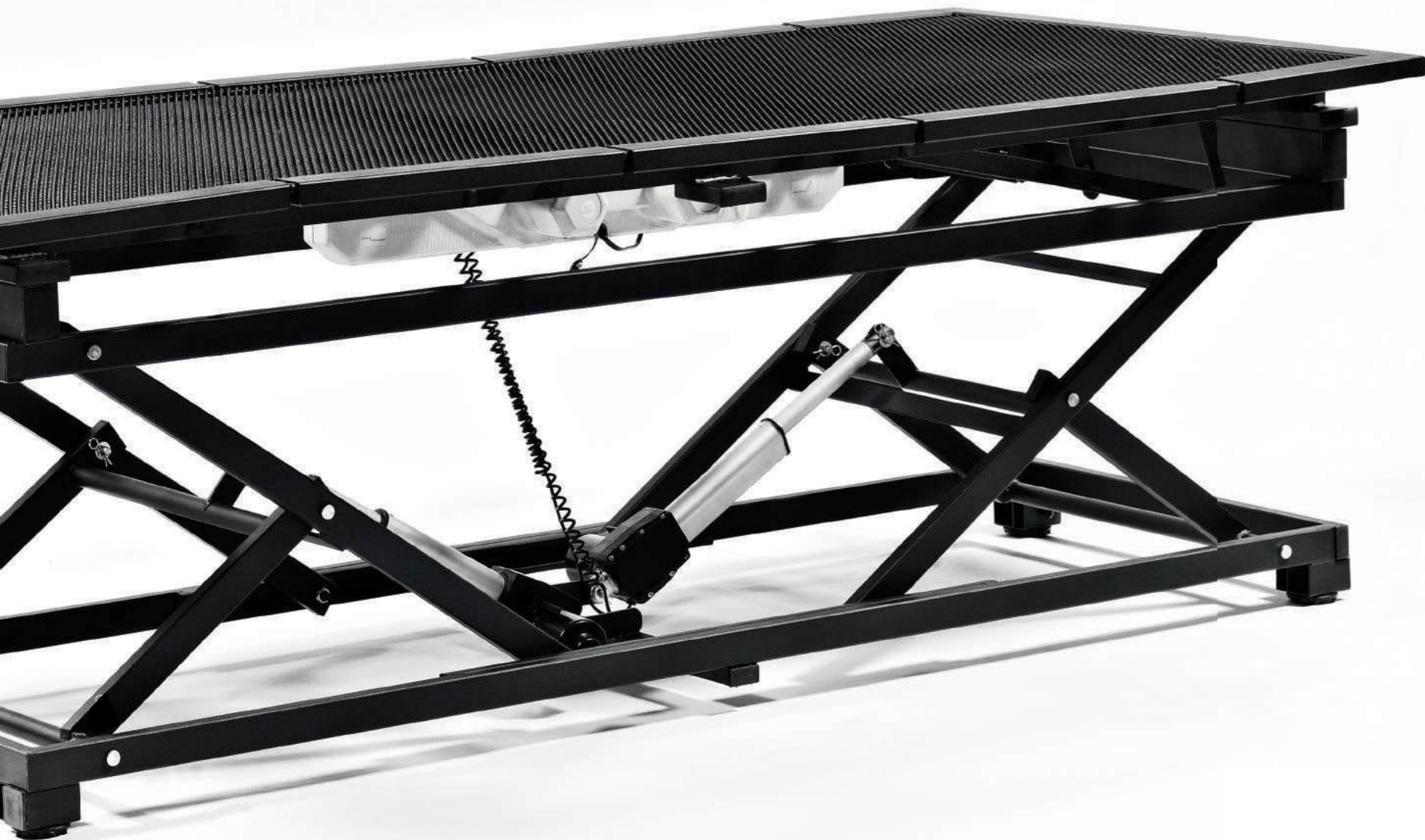

First and foremost, Smartrest Mechanisms are designed to fit best the physiological movements of people in their resting positions. This way, maximum comfort is ensured during resting without damaging the natural structure of the spine and musculoskeletal system.





EXCELLENT DYNAMICS ARE ALL TOGETHER

Smartrest is the name of a special system that can move mechanically, set to different positions and meet needs of people. The system that creates the foundation of a good bed increases the elasticity and ergonomics of the sleeping surface. It ensures balanced distribution of your body weight and helps prevent lower back, back and muscle pains. The silent motor and control system it has offers you the high standard of life and comfort you desire.

CARE YOUR NECK



STF-70-25-42-5K BLACK DYNAMIC

With a single touch on a button on the remote control, the silent motor technology allows you to easily move the head and feet sections of the bed or the entire bed.

Smartrest mechanisms allow you to automatically adjust the bed to the ideal height using the handheld remote control.

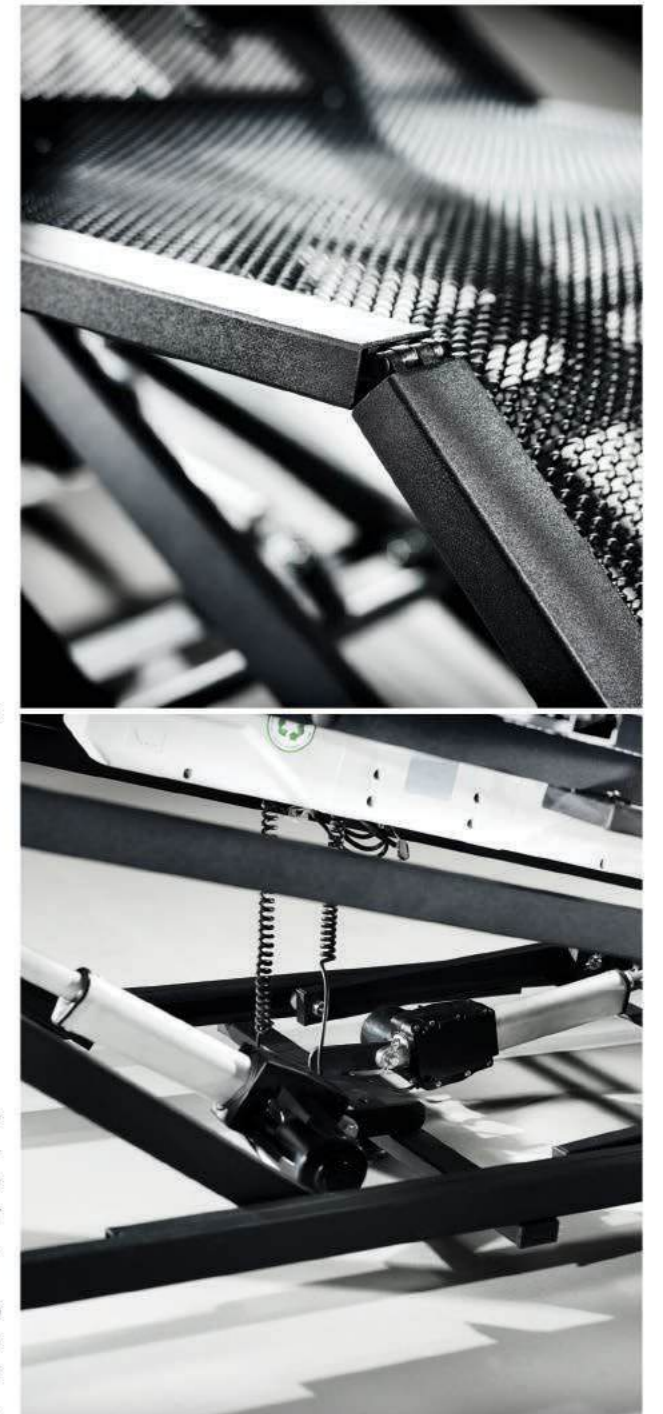

PERFECT MOTION

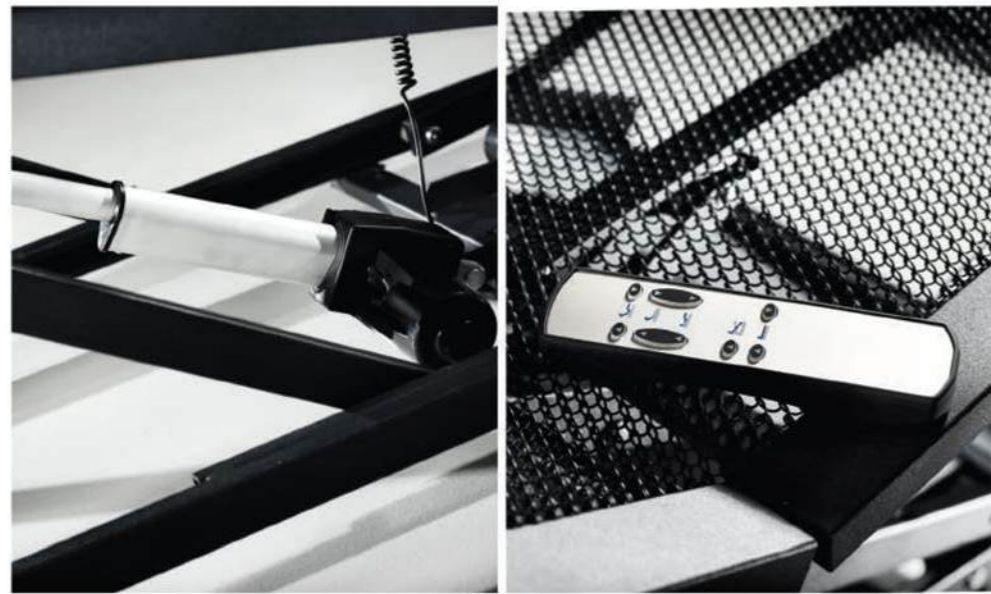

PERFECT MOTION

With Smartrest, it is very easy to change the head and leg positions. You can set the bed to the position you select to benefit from the maximum comfort. With a remote control system that allows you to adjust the height of certain sections of your bed, you will have the complete control of your bed and set the sleeping position you want by controlling the entire bed.



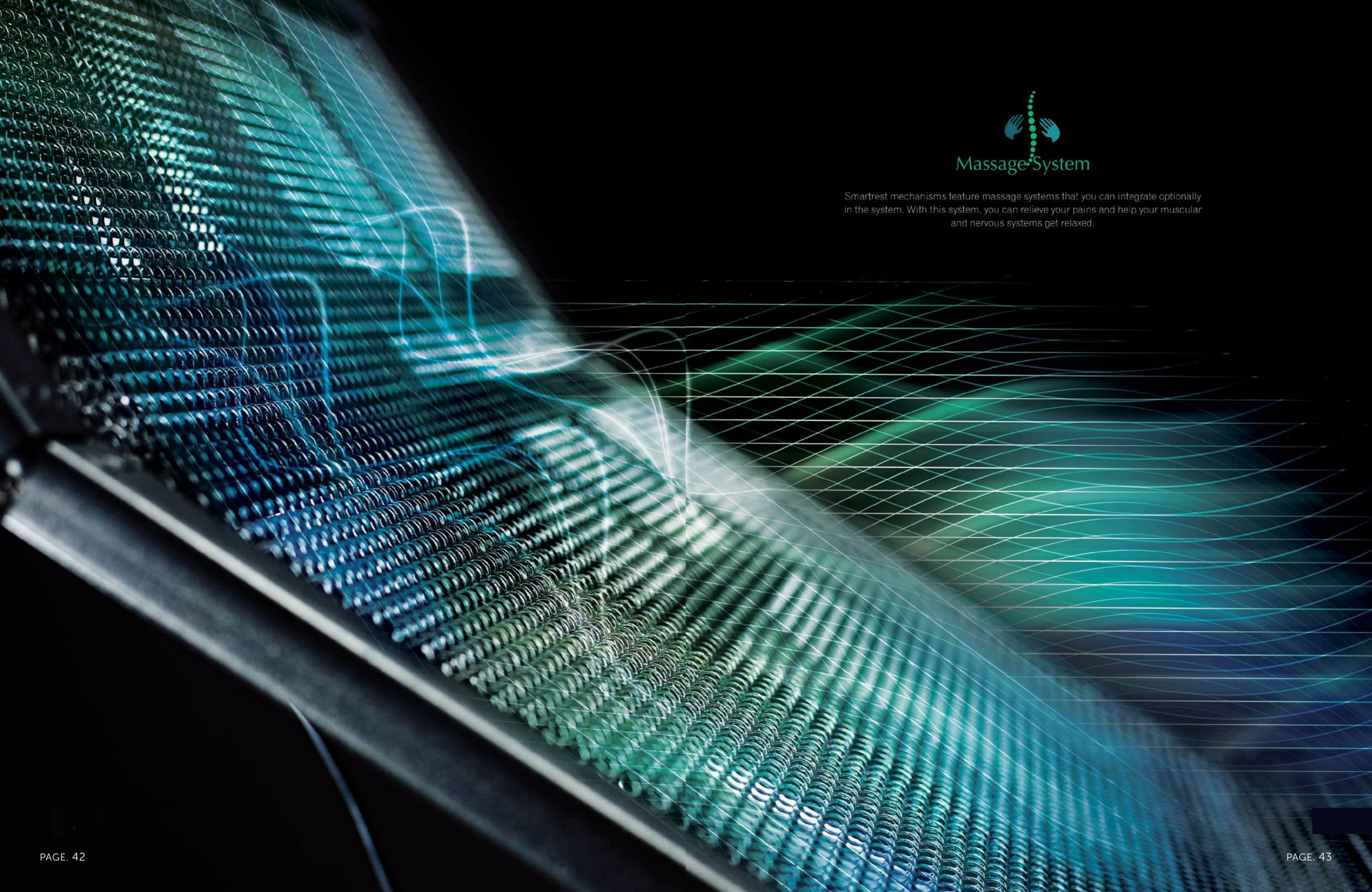

Massage System

Smartrest mechanisms feature massage systems that you can integrate optionally in the system. With this system, you can relieve your pains and help your muscular and nervous systems get relaxed.

STF-90-5K DOUBLE REST



Sleeping is considered by majority of people as an act of satisfying a need. However, it has recently been discussed that sleeping is more than an act of meeting a need. Smartrest mechanisms invite you to a new sleeping experience. Do not miss on the freedom and convenience of setting the position of your bed differently when sleeping, reading and relaxing with Smartrest Mechanisms that allow you to customize your sleeping environment.

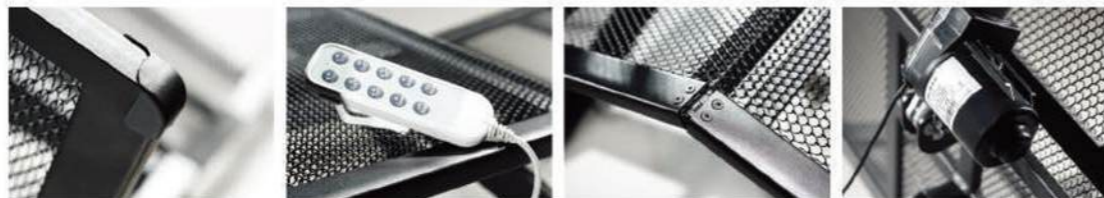

STF-90-5K DOUBLE REST

DOUBLE COMFORT SIT AND SLEEP





STF-90-5K DOUBLE REST

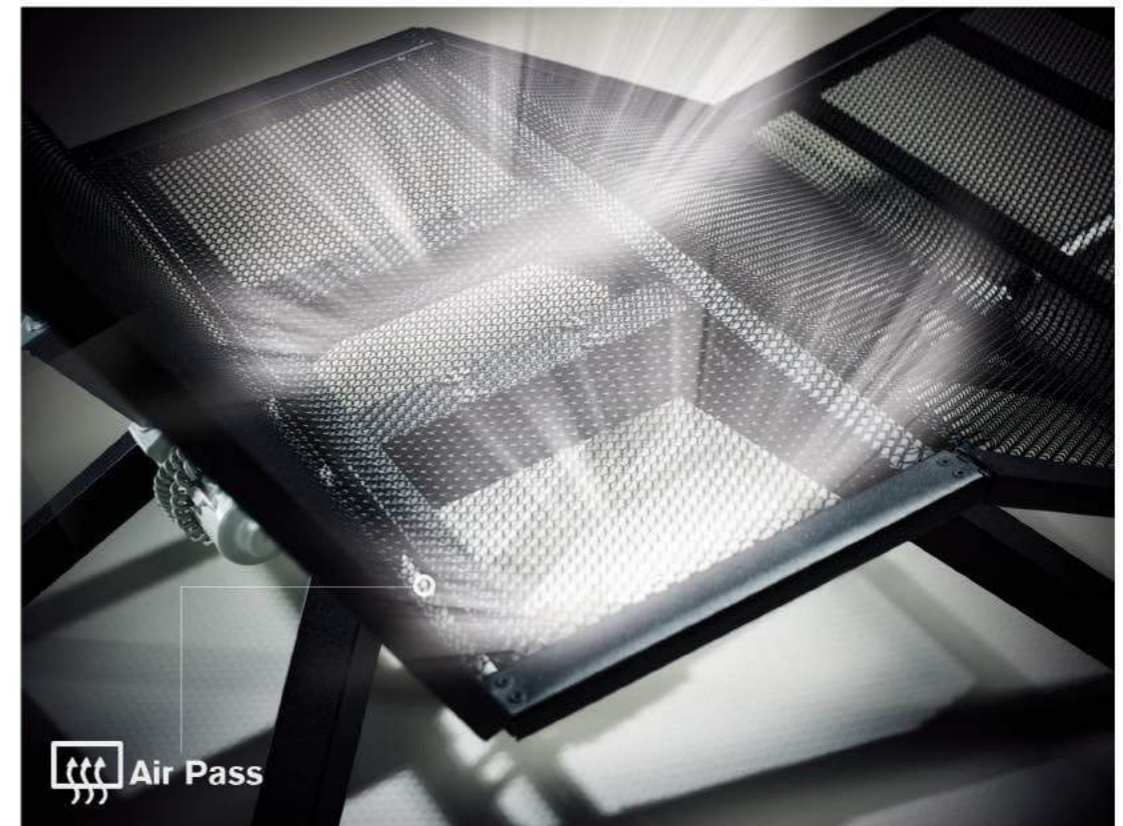

The comfort of a fresh and healthy sleep is waiting for you with the Air Pass technology, which offers air permeability ensured by the metal mesh design and healthy and comfortable sleep for all.



FLEXMOTION

SUPERIOR MOVEMENT CAPABILITY

Smartrest mechanisms, which are easily adjustable with a single touch on a button, offer you countless relaxation positions to support your head, neck, shoulders, back, lower back, hip, legs and feet.



FLEXMOTION



Extremely durable and reliable Smartrest mechanisms offer you the significantly necessary musculoskeletal support and comfort.



FLEXMOTION

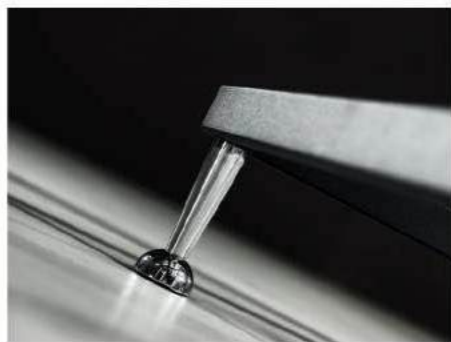

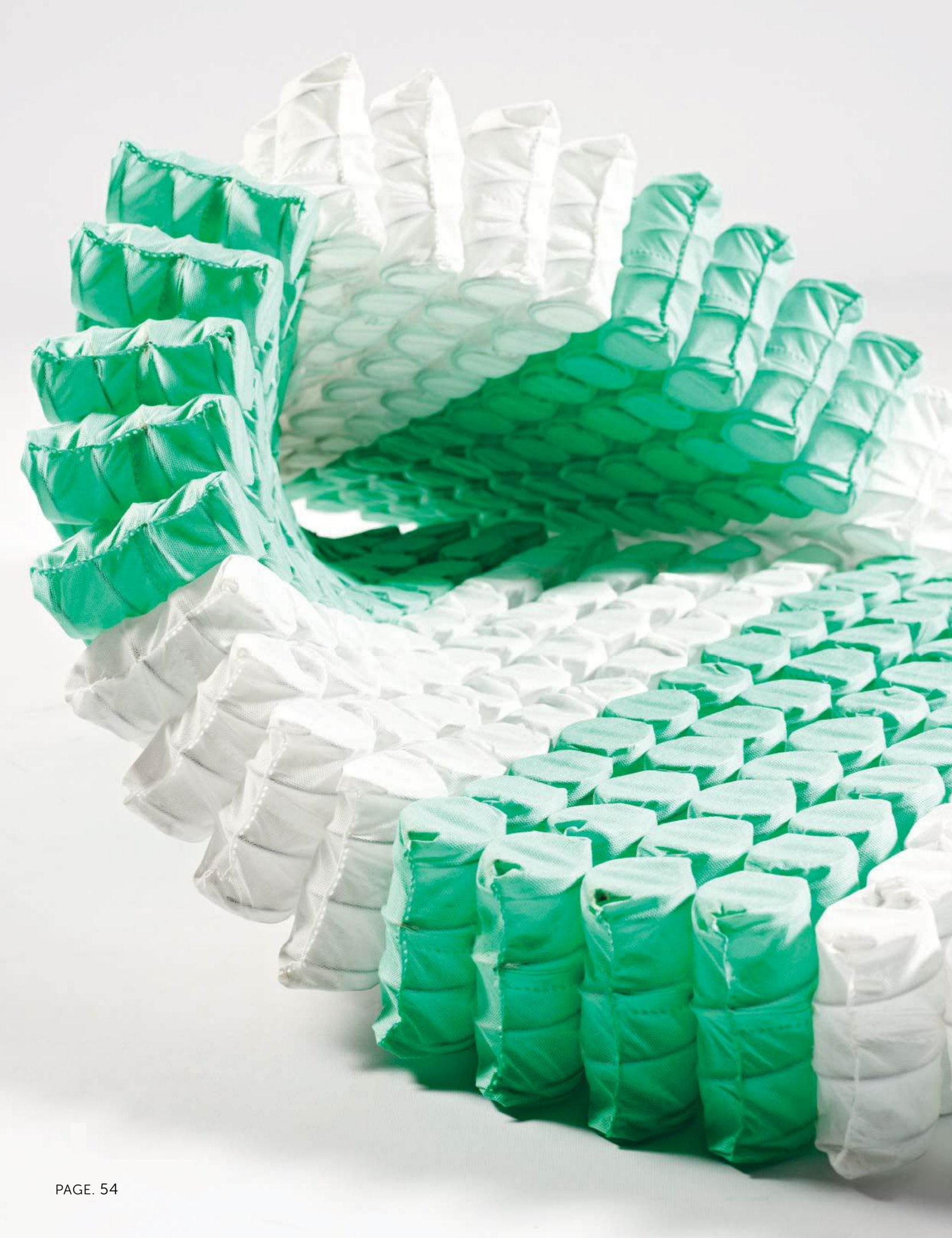

POCKET SPRING SYSTEMS

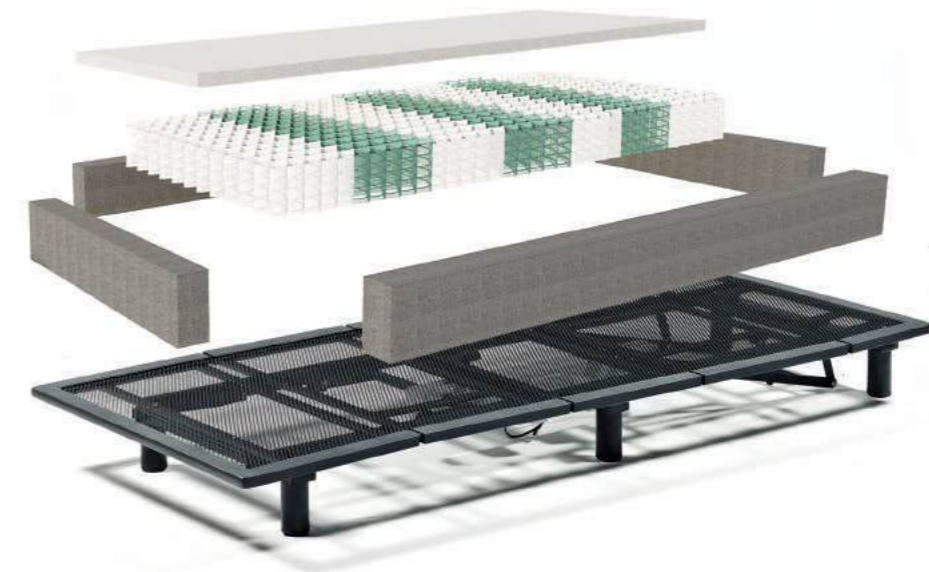

INTEGRATION OF POCKET SPRINGS INTO THE SYSTEM

With the advanced pocket spring systems in Smartrest mechanisms, the pocket springs move separately from each other and start taking shape depending on your body weight from the moment you lie down on the mechanism. This way, your blood pressure is decreased and pain is prevented. Since each spring is located within a pocket, the system prevents sounds and interruption of sleep when turning.

All models of Smartrest mechanisms can be supported with pocket spring systems. The pocket springs that are directly placed on the surface of the system are supported with foam on the sides. The surface of foam used on the pocket springs prevents direct contact of the springs with the body, which increases the comfort of the bed.





STF-15-4K RELAXMOTION



STF-88 CREATION



With the smart resting technology, Smartrest mechanisms offers you the significantly necessary musculoskeletal support and comfort.



STF-67-4K S-LINE METAL FRAME



We have sought an answer to how comfort develops and how to manufacture the best for the human body regarding sleeping. We have conducted many researches to find the most durable materials. Following, we have handed these to the most skilled and experienced craftsmen. Everything has been specially prepared using durable materials. This extensive process has brought forth the new sleeping comfort.



STF-70 HIGH-LOW PERFECT MOTION



With a single touch on a button on the remote control, the silent motor technology allows you to easily adjust the height of the bed, move the head and feet sections of the bed or the entire bed.



STF-28-4K METAL FRAME



With Smartrest, say no more to tossing and turning in bed and waking up in the middle of the night. The relaxing positions that you can set with the adjustable Smartrest will allow you and your partner to enjoy a good night's sleep.



STF-25-4K METAL FRAME



It was designed for different needs at different times to make your life easier. Thanks to the electronic mechanism that consist of dependent parts, you can adjust your bed to the desired position at certain angles.



STF-25-5K METAL FRAME



It was designed for different needs at different times to make your life easier. Thanks to the electronic mechanism that consist of dependent parts, you can adjust your bed to the desired position at certain angles- and without troubling yourself!



STF-27-4K PULLBACK FRAME



Extremely durable and reliable Smartrest mechanisms offer you the significantly necessary musculoskeletal support and comfort.



STF-27-5K PULLBACK FRAME



With the help of the electronic motor, the position of the bed can be customized with the adjustment mechanism for the bedside and leg rest sections.



STF-24-4K METAL FRAME



Our technology offers a relaxed and perfect night's sleep for those who have problems related to sleeping positions.



STF-21 METAL FRAME



Our technology offers a relaxed and perfect night's sleep for those who have problems related to sleeping positions.



STF-23-5K METAL FRAME



STF-23-4K METAL FRAME



STF-22-4K METAL FRAME



Our technology offers a relaxed and perfect night's sleep for those who have problems related to sleeping positions.

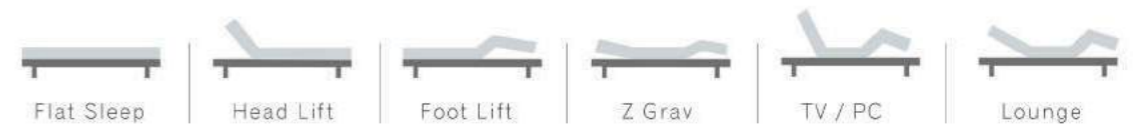

STF-17-4K AMERICAN ADJUSTABLE SYSTEM



In our works for hotels, we are offering technologies that meet personal choices. We understand the importance of sleep and trying to make it understood. Therefore, all our products are manufactured to the liking of those that are looking for health, convenience and comfort.



STF-130-4K MANUAL ADJUSTABLE BED



Smartrest meshed foldable mechanism help prevent back, lower back and muscle pains by ensuring balanced distribution of body weight.



STF-119-4K FOLDABLE SLETTED BED



The lathes made of kiln-dried hornbeam wood allow the bed to constantly breath. It creates the environment that the body needs for a healthy sleep.



STF-42-5K AIRBOXX FRAME



STF-37-4K AIRBOXX FRAME



STF-45 AIRBOXX INSIDE FIX FRAME MESH

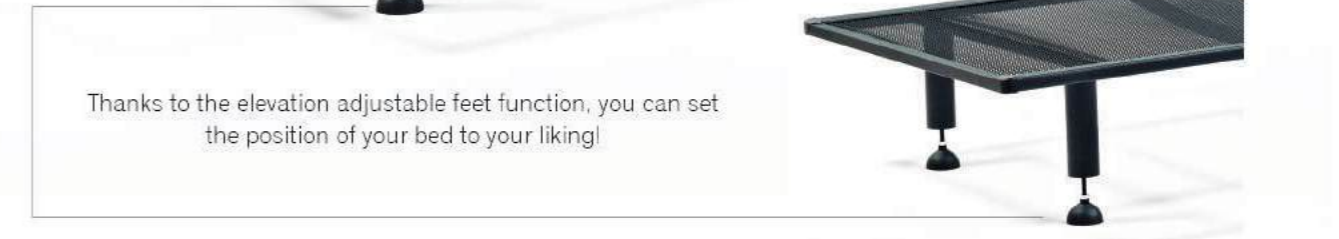

Thanks to the elevation adjustable feet function, you can set the position of your bed to your liking!

STF-141 SLETTED BED



Thanks to the flexible and bendable structure of the lathes, a sleeping environment specific to person and their weight is provided by ensuring that the curves of the body touch the bed.

STF-199 FOLDABLE WOODEN BED

If you are looking for a practical and comfortable solution for your extra bed needs, the foldable bed is just for you.



STF-110 FOLDABLE SPRING BED



Featuring functionality and practical use, the foldable beds can be easily folded and unfolded, making your life easier. The beds can be used in the garden, terrace, balcony, and many other areas since they are easy to move



STF-195 FOLDABLE AIRBOXX MESH BED



The foldable beds are the sleeping systems that can be readied for use by turning on the assembly mechanism whenever you want.



STF-140 FOLDABLE METAL BED



Thanks to its special mechanism, this product becomes a single bed when unfolded and serves as a small pouf when folded. Our product, which offers convenient use in narrow spaces, can easily be relocated.



STF-144 FOLDABLE HOTEL BED



It is a model that is frequently preferred by hotels since it does not deform even when used over a long period of time thanks to the pocket spring and special filling materials that prevent partial dents by evenly distributing the weight across the bed.



STF-190 TWIN BED



The bed base with compartment is a bed with base that has a secondary bed that can easily be hidden inside by folding. Thanks to its special mechanism, it can easily be unfolded into one double bed or two separate single beds.



STF-69 BUNK BED MESH



If desired, it can be used as two separate single beds. The assembly is extremely easy and fun. Its ergonomic lines, elegant design and practicality is what makes the product meet your expectations.



STF-191 BUNK BED



If desired, it can be used as two separate single beds. The assembly is extremely easy and fun. Its ergonomic lines, elegant design and practicality is what makes the product meet your expectations.



STF-18-4K CARE BED

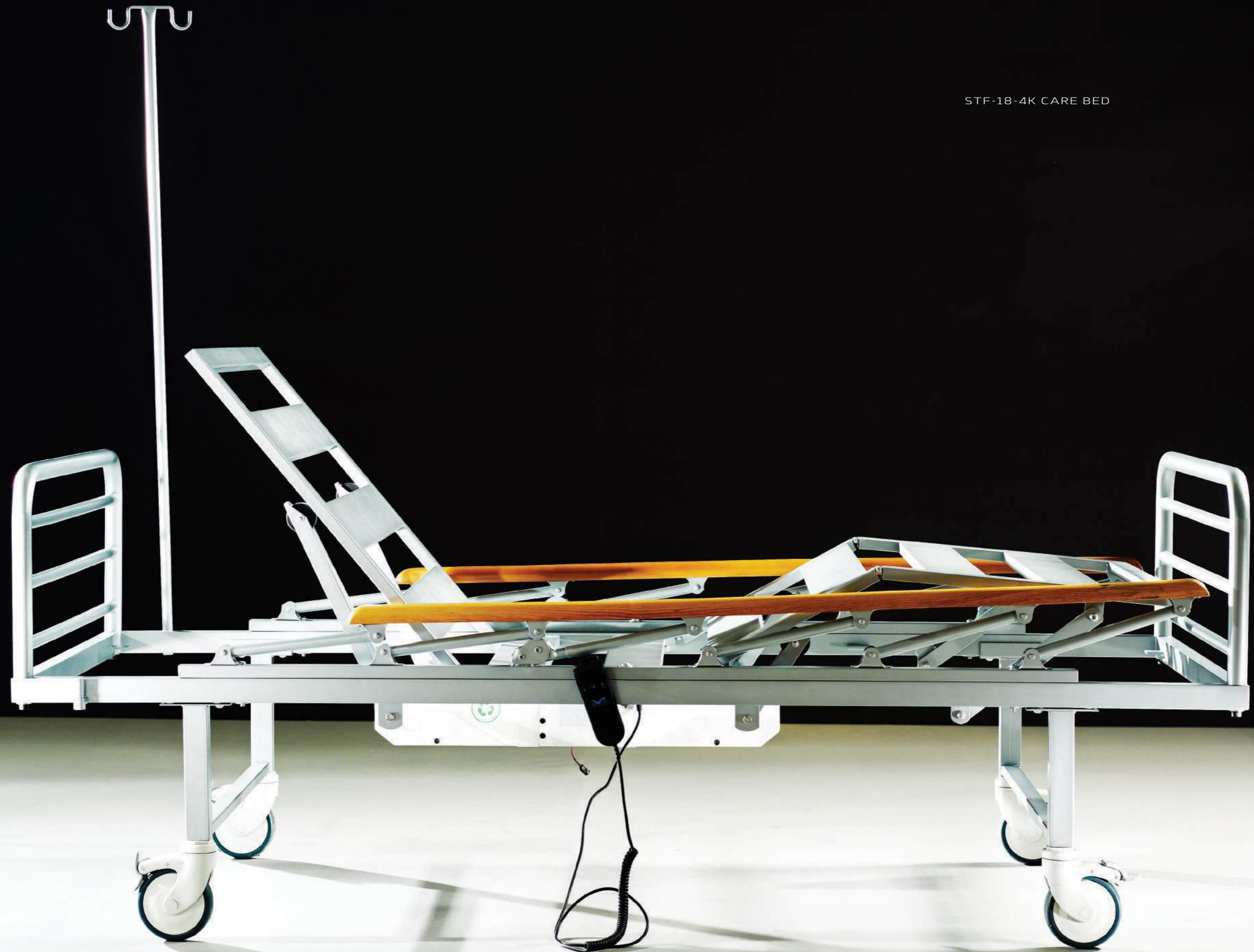

STF-18-4K CARE BED



Offering comfort to those confined to bed for long periods of time, Smartrest mechanisms help prevent sensitization and pressure ulcers on the body. Featuring standard brakes, electrostatic powder coating and locked railing system, our product has a durable and aesthetical structure. Moving in four areas, it has a mechanical setup.



TECHNICAL SPECIFICATIONS



Features	STF-20-5K	STF-10-4K	STF-70-25-42-5K	STF-90-5K	STF-18-4K
Heat up & Down	•	•	•	•	•
Foot up & Down	•	•	•	•	•
Lumbar Support	•	•	•	•	•
Massage					
Elevation Adjustable			•		
Memo Button	•	•	•	•	•
Wireless Remote	•	•	•	•	•
LED Underbed Light	•	•	•	•	•
Usb Plugin	•	•	•	•	•
App Available	•	•	•	•	•
Air Pass Ventilation	•	•	•	•	•
Galaxy Motor	•	•	•	•	•
Weight Capacity	200 kg	200 kg	200 kg	200 kg	200 kg
Waranty	5 years	5 years	5 years	5 years	5 years
Weight (90x200)	14 kg	31.55 kg	79 kg	46.25 kg	46.65 kg

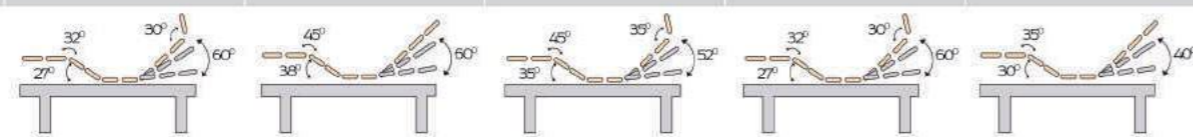

TECHNICAL SPECIFICATIONS



STF-15-4K	STF-88-3-4K	STF-70	STF-24-P-4K	STF-25-4K	STF-27-4K
•	•		•	•	•
•	•		•	•	•
•	•		•	•	•
•	•	•	•	•	•
		•			
•	•	•	•	•	•
•	•	•	•	•	•
•	•	•	•	•	•
•	•	•	•	•	•
•	•	•	•	•	•
•	•	•	•	•	•
200 kg	200 kg	300 kg	200 kg	200 kg	200 kg
5 years	5 years	5 years	5 years	5 years	5 years
19.70 kg	27.55 kg	35.75 kg	11.25 kg	12.30 kg	19.55 kg

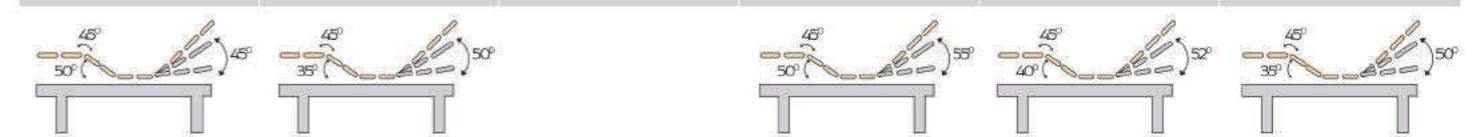

TECHNICAL SPECIFICATIONS



Features	STF-27-5K	STF-67-4K SLINE	STF-25-5K	STF-28-4K	STF-23-5K
Heat up & Down	•	•	•	•	•
Foot up & Down	•	•	•	•	•
Lumbar Support	•	•	•	•	•
Massage	•	•	•	•	•
Elevation Adjustable					
Memo Button	•	•	•	•	•
Wireless Remote	•	•	•	•	•
LED Underbed Light	•	•	•	•	•
Usb Plugin	•	•	•	•	•
App Available	•	•	•	•	•
Air Pass Ventilation					
Galaxy Motor	•	•	•	•	•
Weight Capacity	200 kg	200 kg	200 kg	200 kg	200 kg
Waranty	5 years	5 years	5 years	5 years	5 years
Weight (90x200)	21.70 kg	30.80 kg	14 kg	16.45 kg	9.60 kg

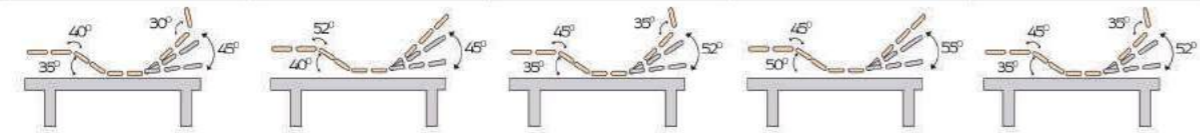

TECHNICAL SPECIFICATIONS



STF-23-P-4K	STF-22-P-4K	STF-42-5K	STF-37-4K	STF-17-4K	
Heat up & Down	•	•	•	•	
Foot up & Down	•	•	•	•	
Lumbar Support	•	•	•	•	
Massage	•	•		•	
Elevation Adjustable					
Memo Button	•	•	•	•	
Wireless Remote	•	•	•	•	
LED Underbed Light	•	•	•	•	
Usb Plugin	•	•	•	•	
App Available	•	•	•	•	
Air Pass Ventilation		•	•		
Galaxy Motor	•	•	•	•	
Weight Capacity	200 kg	200 kg	200 kg	200 kg	
Waranty	5 years	5 years	5 years	5 years	
Weight (90x200)	7.35 kg	5.20 kg	24.85 kg	21.90 kg	48.55 kg



ACCESSORIES



ST-10



ST-160



ST-162



ST-06



ST-163

ACCESSORIES



ST-01



ST-02



ST-03



ST-40



ST-120

ACCESSORIES



ST-70



ST-109



ST-16



ST-20



ST-41

ACCESSORIES



ST-143

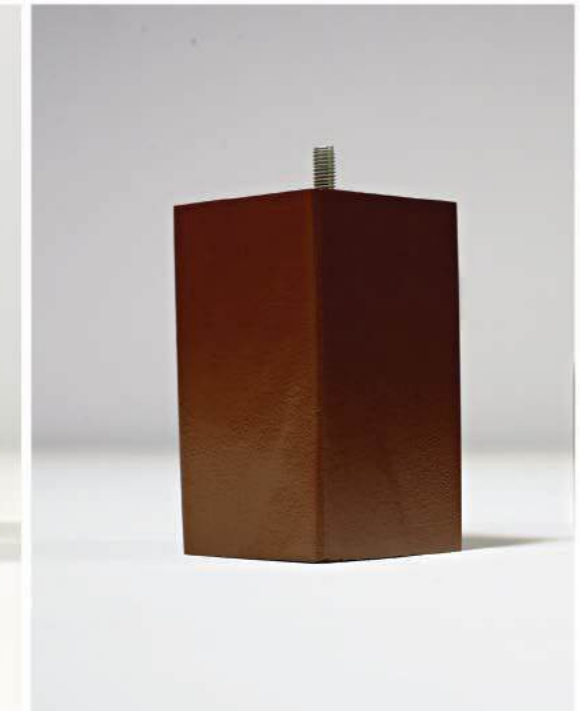

ST-147



ST-144



ST-151

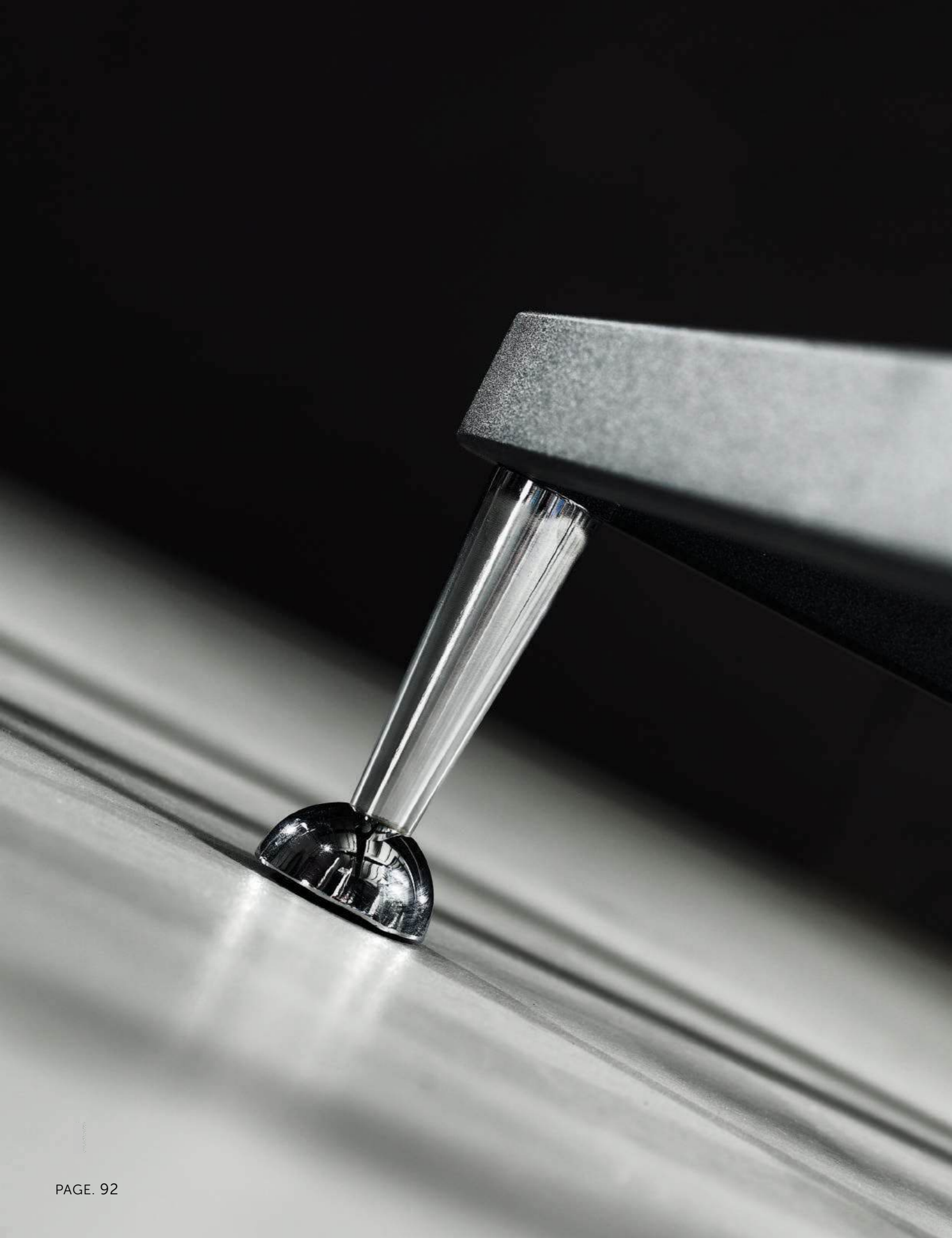

ACCESSORIES



ACCESSORIES



ST-67



ST-67-01



ST-106



ST-133



ST-119



ST-110



ST-112



ST-135

ACCESSORIES



ST-140



ST-137



ST-139



ST-141



ST-138



ST-136



ST-132



ST-151

ACCESSORIES



ST-149



ST-507



ST-505



ST-150



ST-107



ST-108



ST-113



ST-114

ACCESSORIES



ST-124



ST-126



ST-131



ST-145



ST-148

MECHANISM INSTALLATION APPLICATION



MECHANISM INSTALLATION APPLICATION

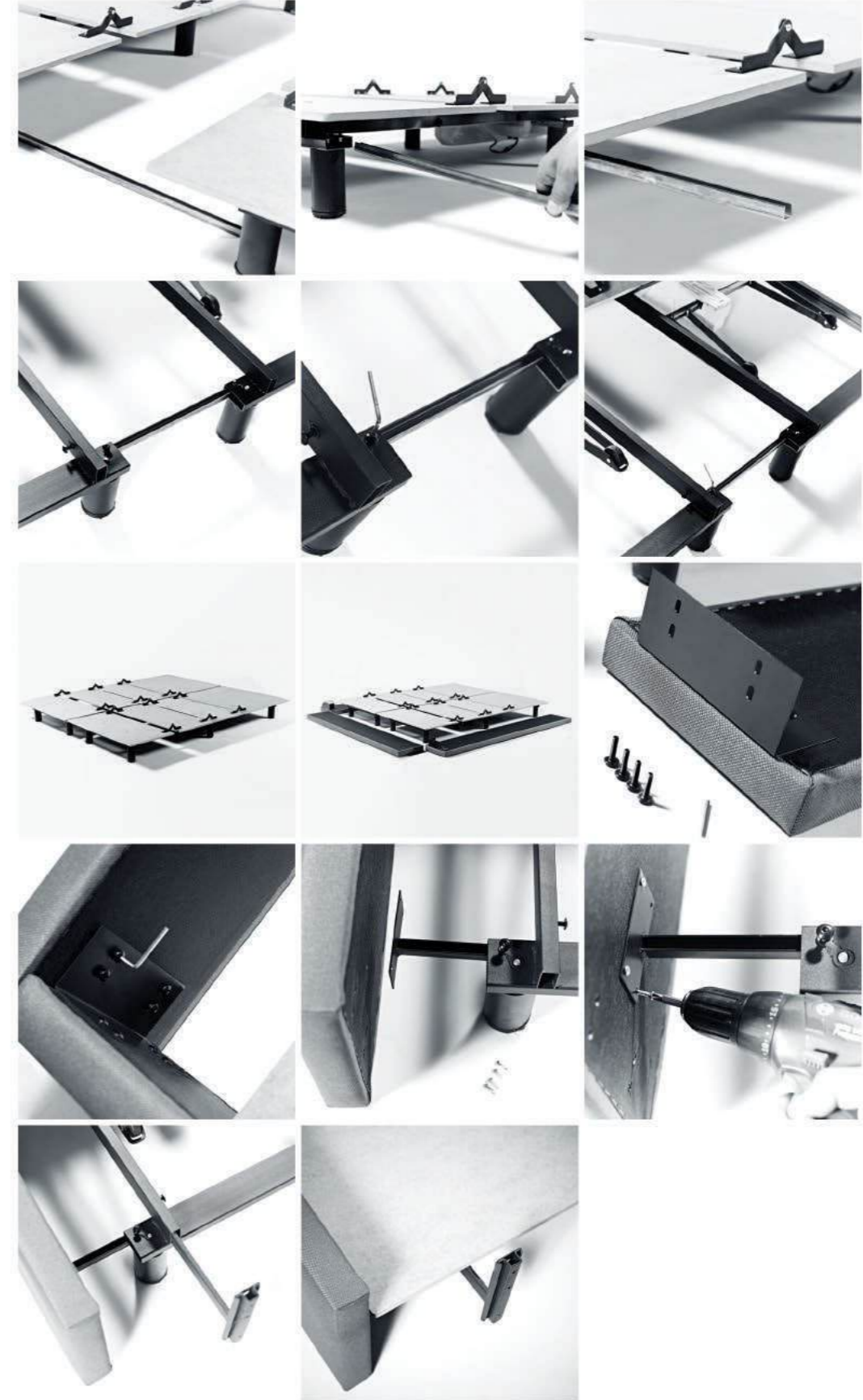

SHIPPING (CONTAINER)

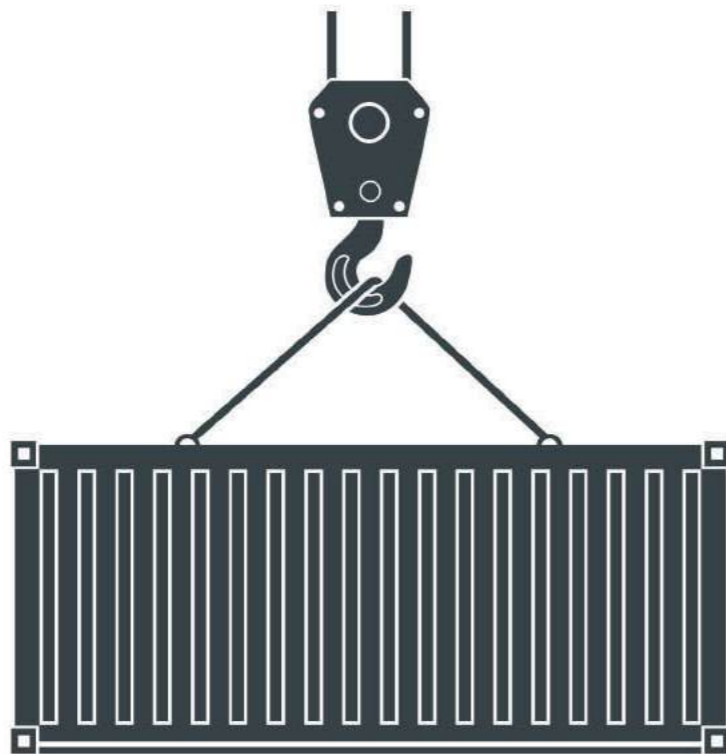

METAL CASE

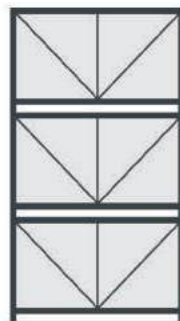

STF 22 / 23 / 73 / 74 / 72

METAL PALLET

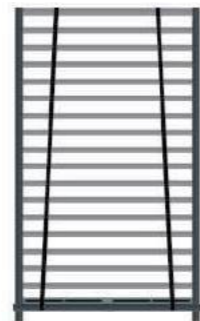

STF 24 / 25 / 27 / 28 / 42 / 37 / 70

BOX

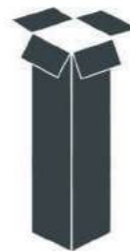

STF 10 / 20 / 90 / 15 / 18 / 88 / 27 / 67 / 73 / 74 / 70 / Foldable Mechanisms

CERTIFICATES

The image shows four Intertek certificates. The first two are 'Test Verification of Conformity' for EMC standards (EN 55014-2-2007, EN 55014-2-2008, EN 60900-2-2014, EN 60900-2-2018) for household appliances. The last two are 'Test Verification of Conformity' for safety standards (IEC 60335-1, IEC 60335-2-10) for household electrical appliances. Each certificate includes the applicant's name (STAR INTERNATIONAL B.V.), address, product description, and the test report number (1806012915HA-V02).

The image shows two summary pages from the Intertek reports. The left page summarizes EMC compliance with EN 55014-2-2007, EN 55014-2-2008, EN 60900-2-2014, and EN 60900-2-2018. The right page summarizes safety compliance with IEC 60335-1 and IEC 60335-2-10. Both pages include the project engineer's name (York Du) and the reviewer's name (Anfjellen).

The image shows three Intertek test report covers for IEC 60335-1. Each cover includes the report number (1806129094-01), date of issue (2018-04), total number of pages (36), and the name of the testing laboratory (Intertek Testing Services Ltd, Shanghai). The covers also list the applicant's name (STAR INTERNATIONAL B.V.) and the address (D.C. Lufeng 2A 6027 8th Avenue Netherlands).



STARINTERNATIONAL.NL

STARINTERNATIONAL
Doctor C. Lelyweg 2A
6827 BH Arnhem / NETHERLANDS
Phone: +31 (0) 263391849
Fax: +31 (0) 263391658
info@starinternational.nl

